

155Mbps 1X9 ST Duplex Receptacle Transceiver Module for ATM, SONET OC-3/SDH STM-1, Fast Ethernet

OPT-155A2H4

Feature

- Multisourced 1x9 package style with Duplex ST receptacle
- Full compliant with all major standard
- PECL Differential Inputs and Outputs
- Wave Solderable and Aqueous Washable
- For distance of up to 2km
- Single +3.3 V power supply

Applications

- SONET/SDH Equipment Interconnect
- 100Base Fast Ethernet
- 155Mbps ATM

Absolute Maximum Ratings

Parameter	Symbol	Min.	Typ.	Max.	Unit	Reference
Storage temperature	T _s	-40		85	°C	
Lead soldering temperature	T _{SOLD}			260	°C	
Lead soldering time	t _{SOLD}			10	sec.	
Supply voltage	V _{CC}	0		6	V	

Recommended Operating Conditions:

Parameter	Symbol	Min.	Typ.	Max.	Unit	Reference
Ambient Operating Temperature	T _A	0		70	°C	
Supply voltage	V _{CC}	3.135	3.3	3.465	V	
Transmitter Data input voltage-Low	V _{IL} - V _{CC}	-1.810		-1.475	V	
Transmitter Data input voltage-High	V _{IH} - V _{CC}	-1.165		-0.880	V	
Transmitter Differential Input Voltage	V _D	0.3		1.6	V	
Data Output Load	R _{DL}		50		Ω	

 DELTA ELECTRONICS, INC.	TITLE			DATE:	
	OPT-155A2H4			22. Feb.2002	
	WRITTEN	CHECKED	APPROVED	DOCUMENT NO:	REV:
James Cheng	Teddy Kuo	YY. Tsai			

155Mbps 1X9 ST Duplex Receptacle Transceiver Module for ATM, SONET OC-3/SDH STM-1, Fast Ethernet

OPT-155A2H4

Transmitter Performance Specifications:

Parameter	Symbol	Min.	Typ.	Max.	Unit	Reference
Power supply voltage	V _{CC}	3.135	3.3	3.465	V	
Supply current	I _{CC}			200	mA	
Output optical power (avg.)	P _O	-20		-14	dBm	Note (1)
Optical extinction ratio		9			dB	Note (1)
Center wavelength	λ _c		1310		nm	
Spectral width	Δλ			200	nm	
Optical risetime	t _r	0.6		3.0	ns	Note (2)
Optical falltime	t _f	0.6		3.0	ns	Note (2)
Duty Cycle Distortion	DCD			0.6	ns	
Jitter				1.0	ns	

Note (1). Measured at the end of 5 meters of 62.5/125 um Graded index fiber using 155Mbps, PRBS 2²³-1 signal at the beginning of life

Note (2). These are 10%~90% values

Receiver Performance Specifications:

Parameter	Symbol	Min.	Typ.	Max.	Unit	Reference
Power supply voltage	V _{CC}	3.135	3.3	3.465	V	
Supply current	I _{CC}			100	mA	
Data output voltage-Low	V _{OL} - V _{CC}	-1.85		-1.47	V _{CC}	
Data output voltage-High	V _{OH} - V _{CC}	-1.16		-0.88	V _{CC}	
Optical input sensitivity (avg.)	P _{IN}			-31	dBm	Note (1)
Optical input saturation (avg.)	P _{SAT}	-14			dBm	Note (1)
Optical wavelength	λ		1310		nm	
Output risetime	t _r	0.35		2.2	ns	Note (2)
Output falltime	t _f	0.35		2.2	ns	Note (2)
Jitter				1.0	ns	
Signal detect- Assert	P _A			-33	dBm	
Signal detect- Deassert	P _D	-48			dBm	
Signal detect Hysteresis	P _A -P _D	0.5			dB	

Note (1). With BER better than or equal 1x10⁻¹⁰, measured in the center of the eye opening with 2²³-1 PRBS at 155Mbps

Note (2). These are 20%~80% values

 DELTA ELECTRONICS, INC.	TITLE			DATE:	
	OPT-155A2H4			22. Feb.2002	
	WRITTEN	CHECKED	APPROVED	DOCUMENT NO:	REV:
James Cheng	Teddy Kuo	YY. Tsai			

155Mbps 1X9 ST Duplex Receptacle Transceiver Module for ATM, SONET OC-3/SDH STM-1, Fast Ethernet

OPT-155A2H4

Connection Diagram

Receiver Signal Ground
Receiver Data Out
Receiver Data Out Bar
Receiver Signal Detect
Receiver Power Supply
Transmitter Power Supply
Transmitter Data In Bar
Transmitter Data In
Transmitter Signal Ground

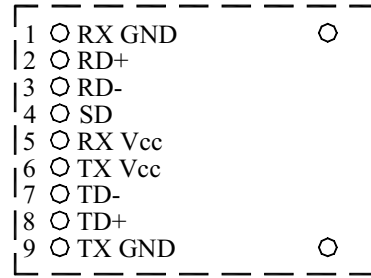

Top View

Recommended Circuit Schematic

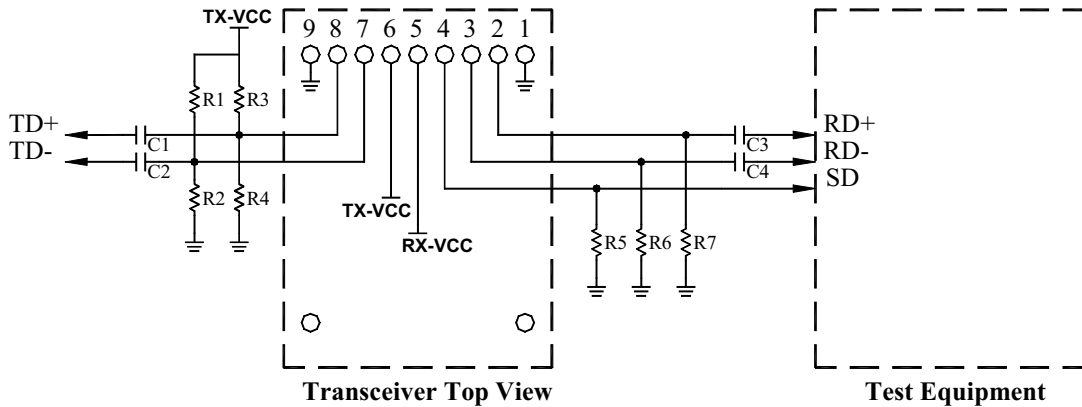

Note:
R1=R3=82 Ω
R2=R4=130 Ω
R5=270 Ω
R6=R7=150 Ω
C1=C2=C3=C4=C6=C8=100 nF
C5=100 μF
C7=C9=10 μF
L1=L2=15 μH or ferrite inductor

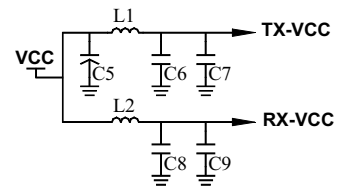



	TITLE			DATE:	
	OPT-155A2H4			22. Feb.2002	
	WRITTEN	CHECKED	APPROVED	DOCUMENT NO:	REV:
James Cheng	Teddy Kuo	YY. Tsai			

155Mbps 1X9 ST Duplex Receptacle Transceiver Module for ATM, SONET OC-3/SDH STM-1, Fast Ethernet

OPT-155A2H4

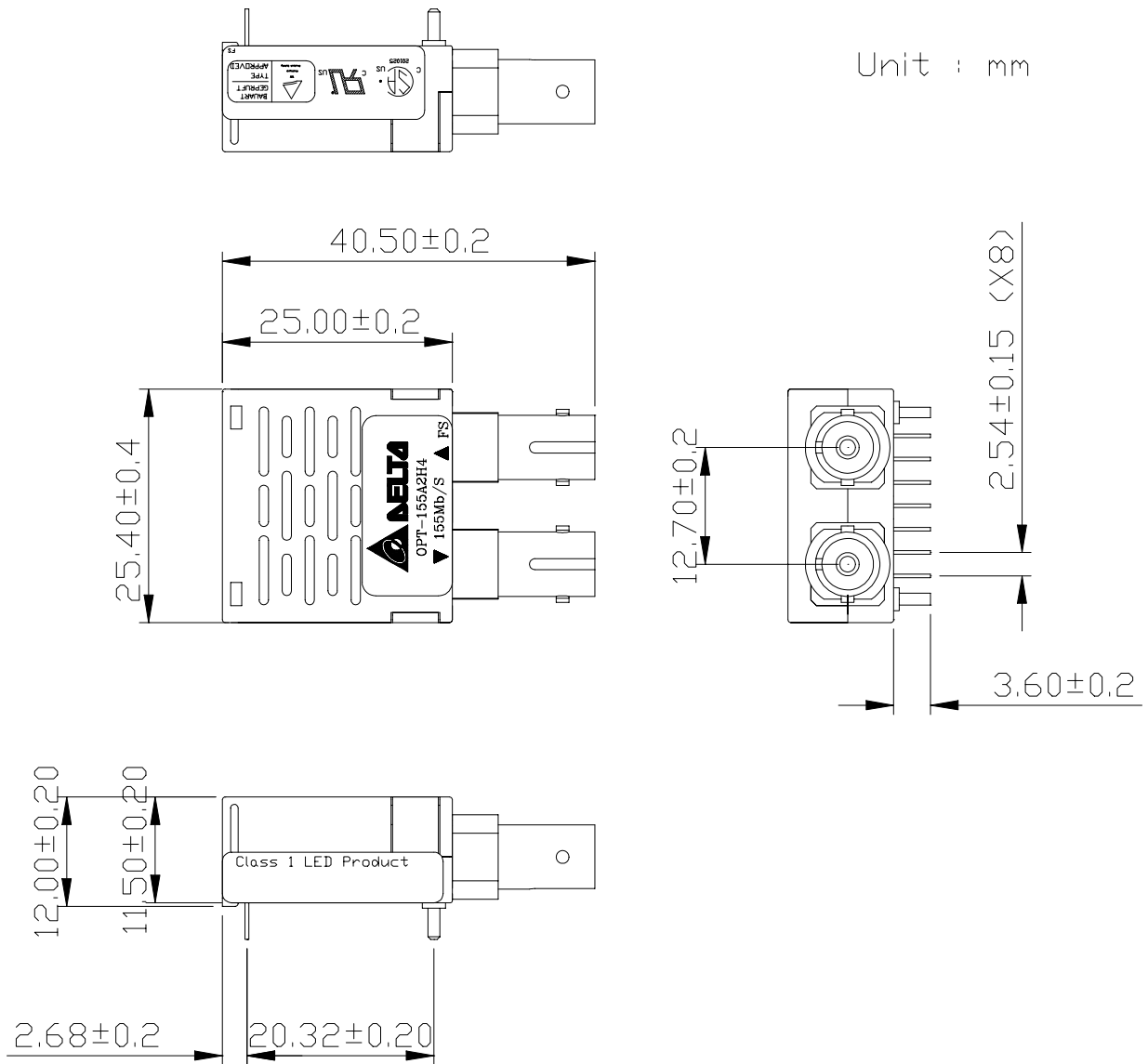
Mechanical Dimensions



 DELTA ELECTRONICS, INC.	TITLE			DATE:	
	OPT-155A2H4			22. Feb.2002	
	WRITTEN	CHECKED	APPROVED	DOCUMENT NO:	REV:
James Cheng	Teddy Kuo	YY. Tsai			

**155Mbps 1X9 ST Duplex Receptacle Transceiver Module for ATM,
SONET OC-3/SDH STM-1, Fast Ethernet**

OPT-155A2H4

Test Item	Reference	Qty'	Evaluation
(#1) Electromagnetic Interference EMC	FCC Class B EN 55022 Class B CISPR 22	5	(1) Satisfied with electrical characteristics of product spec. (2) No physical damage
(#2) Immunity : Radio Frequency Electromagnetic Field	EN 61000-4-3 IEC 1000-4-3	5	
(#3) Immunity : Electrostatic Discharge to the Duplex SC Receptacle	EN 61000-4-2 IEC 1000-4-2 IEC 801.2	5	
(#4) Electrostatic Discharge to the Electrical Pins	MIL-STD-883C Method 3015.4 EIAJ#1988.3.2B Version 2, Machine model	5	

 DELTA ELECTRONICS, INC.	TITLE			DATE:
	OPT-155A2H4			22. Feb.2002
	WRITTEN	CHECKED	APPROVED	DOCUMENT NO:
James Cheng	Teddy Kuo	YY. Tsai		